



Thank you for choosing BabyBuddha Products

We are committed to quality products, amazing service,
and helping with all your baby needs.

BabyBuddhaProducts.com



@MyBabyBuddha

#BabyBuddha | #MyBabyBuddha



Portable Breast Pump Kit
User Guide

Box Check!

Here's what is included in your box. Please check to make sure you have everything before you begin!



Pump Motor

Wall-Plug and USB-C
Charging Cable



(2) Two Bottles

(2) Hygiene Covers,
Bottle Bases, &
(2) slow flow nipples



(2) Two 24mm Flange Kits

Massage Cushions,
Flange Covers, duckbill valves
& silicone diaphragms



Tubing Kit

(3) Universal Tubes
and T-Connector



Carrying Tote

High-Quality Drawstring Bag
For on-the-go Pumping



Detachable Lanyard

CONTENTS

- 1..... Welcome to the BabyBuddha Family
- 3..... Important Safety Features
- 5..... LCD Display and Buttons
- 6..... Components
- 7..... Pump Assembly
- 9..... How to Use The Pump
- 11..... Cleaning and Storage
- 13..... Additional Important Information
- 15..... Troubleshooting
- 16..... Warranty Information

WELCOME TO THE BABYBUDDHA FAMILY!

More than just a product...

Thank you for your purchase and trusting our company to help support you on your journey. We are so excited to welcome you to the BabyBuddha family! We founded BabyBuddha to give moms, parents, and individuals like YOU back their freedom. We hope that you can use our products to get the absolute most out of your occasional or exclusive pumping journey. Most importantly, we are here to help and support you. If you have any questions or concerns along the way, please do not think twice about reaching out to us for help. You will find detailed contact information inside this manual and we encourage you to reach out.

Hey
Super Mom You're Invited!

Don't forget to join our private
BabyBuddha Facebook Support Group!

[Facebook.com/groups/babybuddha](https://www.facebook.com/groups/babybuddha)

For your privacy, only BabyBuddha customers are allowed to join this private group. Please allow 24-hours for our team to accept your request to join. If your request is not approved within 24-hours, please email our support team for help getting into the group: Support@BabyBuddhaProducts.com



With your superpower abilities, and BabyBuddha products, a whole new world of FREEDOM, versatility, and productivity awaits. Maybe even a nap with the time saved. This pump has the same features as the individuals that use it. You are strong, incredible, powerful, and most importantly...

You are LIMITLESS



@MyBabyBuddha

#BabyBuddha | #MyBabyBuddha

IMPORTANT SAFETY FEATURES



Please read all instructions before using this product.

The BabyBuddha Pump is intended to be used by lactating women to collect breast milk. This product is intended for a single user and is not designed for multi-use. Use by more than one person may present a health risk, affect the unit performance integrity, and voids our warranty policy. If you are an individual who is infected with Hepatitis B, Hepatitis C, or Human Immunodeficiency Virus (HIV), pumping breast milk instead of nursing will not reduce or remove the risk of transmitting the virus to your baby through your breast milk. Please seek immediate further guidance from your healthcare professional.

Before each use of this product be sure to visually inspect the unit and the individual components for any cracks, warping, tears, chips, discoloration, or signs of wear. Please follow the recommendations for part replacement and maintenance located in this manual for optimal performance.









- Do not use this product while bathing or showering.
- Do not place in or around any water or other unsecured liquid.
- Do not reach for the unit if it has fallen into water. Unplug the product immediately.
- Never immerse the main pump unit in water or any liquid.
- This product should never be left unattended when plugged in.
- Unplug this unit from the USB-C port and the wall adapter when not in use.



To avoid electric shock, damage, injury or fire:

- Use product only for intended use as described in this manual.
- Close supervision is necessary when this product is used near infants or children.
- Never operate this product if it has a damaged cord, plug, charging port, if it has been dropped or damaged, dropped into water, liquid has gotten into the unit, or if any parts are broken or missing.
- Keep the cord and unit away from heated surfaces.
- Do not place or store this product where it can be pulled and fall.
- Do not use attachments unless recommended by BabyBuddha Products.
- Never use while sleeping or drowsy.
- Do not disassemble or modify this product.
- Do not inhale or swallow small parts. Some parts are a choking hazard to small children.
- Do not use outdoors or operate where aerosol (spray) products are being used, or oxygen is being administered.
- Exposure to dust, light, including sunlight, liquids, heat, and moisture can adversely affect the safety and performance of this product.
- Clean and sanitize all parts that come into contact with the breast and breast milk prior to first use.
- Do not use chemicals, solvents, or abrasives with this product.
- If pumping is uncomfortable or causing pain, turn off the unit and break the suction seal between the flange and the breast tissue with your finger.

Button and display instructions

| | |
|--|---|
| Power Symbol |  |
| Charging Symbol |  |
| Suction Power Level |  |
| LCD Time Display |  |
| Stimulation Mode |  |
| Expression Mode |  |
| Power Button |  |
| Stimulation and Expression Mode Switch |  |



The Features of the BabyBuddha Electric Breast Pump

- This product has a stimulation mode and an expression mode, you can adjust the suction level to your desired comfortability.
- LCD display.
- Rechargeable lithium battery. Battery should last for approximately one hour after a full charge. **DO NOT OVERCHARGE.** Charge for 4 hours MAX for full charge. This product can be used while charging.
- Ability to hang the unit from neck (lanyard provided) for hands free usage.
- USB-C Power gives the ability to charge through multiple sources.
- Anti-backflow design.
- Track ball allows for easy control.
- Compact and portable design allows for easy use and storage.

Components

Please inspect the following components before use.

If there are missing or damaged components: please email support@babybuddhaproducts.com



- Upper Cover
(DO NOT SUBMERGE THE COVERS IN WATER)
- Silicone Diaphragm
replacement recommended every 8 weeks
- Pump Body Top
- Massage Cushions
- Hygiene Cover
- Duckbill Valve
replacement recommended every 4-5 weeks.
(These duckbill valves are not interchangeable with the duckbill valves used for the manual pump.)
- Bottle Cover
- Bottle
- Screw Cap
- Bottle Stand
- PVC Tubing
- Pump Motor
- PVC Connector
- T-connector
- USB-C Power Line
- AC Adapter

The components of the machine are dishwasher safe and BPA free.

Assembly of the pump body

- 1 Snap membrane onto valve until membrane lies completely flat. If you have duckbill valves they do not require assembly.



- 2 Push assembled valve and membrane or duckbill valves tightly onto pump body.

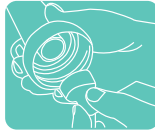

- 3 Attach the massage cushion on the pump body.

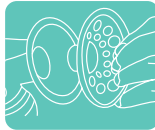

- 4 Place the silicone diaphragm into the cylinder on pump body.



- 5 Screw the upper cover onto the pump body.



- 6 Insert one end of a PVC tube into the air port of the upper cover.



- 7 Screw bottle onto the pump body top.



- 8 Insert the PVC connector into the hole of the pump motor.



- 9 Insert the micro USB-C end into the motor, and attach the USB-C end into USB-C socket adapter. Insert adapter plug into socket.



- 10 Please maintain correct upright posture while pumping. Upon completion, please keep milk refrigerated. Keep electric parts dry, and thoroughly clean components before and after each use.



How to use the Pump





1. Assembly of pump

- Wash and sterilize components (do not wash motor) before use.
- Wash hands thoroughly before use.
- Use instructions to make sure pump has been assembled correctly.
- Gently massage breasts
- Make sure you are sitting (or standing) upright and leaning slightly forward.
- Place flanges (with massage cushions attached) over the nipples assuring an airtight fit.

2. Using the pump

-  is the on/off button. Connect power supply (if fully charged, connecting a power supply is not required at this time). When pump is turned on, it is automatically set to the automatic stimulation mode. It will start at level 1, and increase every 45 seconds until it reaches level 5 (max in stimulation mode). If you manually change any levels on pump, automatic stimulation mode is turned off.
- Use of manual mode: The track ball can be rolled up/down to adjust the gear level. To change over to expression mode, lightly press down the track ball. Gears can be adjusted in this mode (maximum of level 9) also through the use of the track ball.

3. Reading the display

-  is the power symbol (when this starts blinking, recharging is required).
-  appears when pump is charging. This will blink while charging, and once charging is complete, it will no longer blink.
- "L:88" is the gear level. Stimulation mode has 5 levels, expression mode has 9 levels.
- "25" is the time display to show how long you have been pumping. Will automatically turn off after 30 minutes.
- "" is the expression mode.
- "" is the stimulation mode.

4. Adjusting to comfort

- The BabyBuddha breast pump can be adjusted for comfort. As you learn how your body handles pumping with the breast pump, it will get easier to maximize pumping output comfortably.

Note:
Do not overfill the bottle. Once complete, turn off pump and remove all components from the machine. Store the pump at room temperature inside a protective bag to prevent dirt and debris from getting inside the pump.

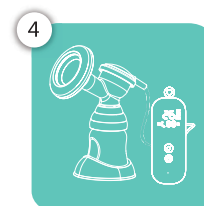
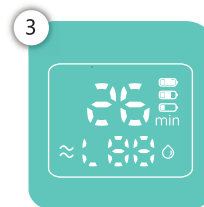
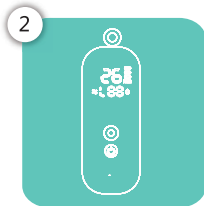

Pumping Tips

- It is important to be as relaxed and comfortable as possible.
- It may take 10-15 minutes to collect milk from both breasts when double pumping, single pumping may take 10-15 minutes for each side.
- Familiarize yourself with the breast pump and how to operate it before first use.
- Do not overfill the container.
- Do not lay down or tilt the container when milk is in it and tubing is still attached.
- Remove tubing from upper cover before placing down the bottles.
- If breastfeeding becomes painful, stop using pump and contact your healthcare provider.

Cleaning & Sterilization

- Wash hands before touching breasts and components.

Before first use:

- Disassemble and wash all parts that come in contact with breast or milk, and sanitize these components by flash boiling for 60 seconds.

After each use:

- Disassemble and wash all parts that come in contact with the breast or milk in warm soapy water.
- Rinse in warm water.
- Air-dry on a clean towel, and cover up all parts when not in use.
- All parts may also be washed on the top rack of a dishwasher.

Storing Breast Milk

- When freezing, do not fill containers more than 3/4 full in order to allow for expansion.
- Label containers with the date of pumping
- Please refer to the table on the next page for storage tips.

Cleaning & Storing

Storing Breast Milk (For Healthy Term Babies)

| | RoomTemperature | Refrigerator | Freezer |
|--------------------------------|-----------------|--------------|----------------------------|
| Fresh expressed breast milk: | 4 hours | 5-7 days | 3-4 months |
| Previously frozen Breast milk: | Do not store | 24 hours | Never refreeze thawed milk |

Important

- Plastic bottles and component parts become brittle when frozen and may break when dropped.
- Bottles and components may become damaged if mishandled.
- Do not use breast milk if bottles or components become damaged.
- Always clean components prior to first use and after each use.

Indication for use

The BabyBuddha pump is a powered breast pump to be used by lactating women to collect breast milk. It is intended for a single user.

NOTE

Your breastfeeding routine is best established after 4 weeks. Therefore it is recommended to start using the pump after this routine is established or as instructed by your healthcare provider.

DANGER: To avoid the risk of electrocution



- Always unplug machine immediately after use.
- Do not use while in or around water.
- Do not place or drop into any other liquid.

Washing Instructions

1. Wash your hands thoroughly before each assembly and use.
2. Wash and sterilize components indicated in **GREEN**.
3. Parts should be washed thoroughly with hot soapy water and sterilized BEFORE FIRST USE by boiling for 60 seconds. Do not boil for more than 60 seconds as parts may become distorted. Do not use parts if they are compromised.
4. After each use wash all parts that come into contact with breast milk. Sterilize as needed or as indicated by your healthcare provider.
5. All parts may be flash boiled (no longer than 60 seconds), washed on the top rack of a dishwasher, in a UV sterilizer (using heat no higher than 212 degrees, or a microwave sterilization method).
6. Allow silicone components to dry in their state of actual use, not inverted. This can cause warping and issues with functionality.

DO NOT WASH

**AC Adapter - USB-C Power Cord - Lanyard and Clip
Pump Motor - Tubing Connector - PVC Tubing
T-Valve Selector - Upper Cover**

WASH

**Silicone Diaphragm - Flange Component -
Massage Cushion - Hygiene Cover-Silicone Duckbill -
Bottle - Bottle Stand - Bottle Cap Nipple -
Bottle Collar**

Important

WARNING: To avoid fire, or serious burns:



- BabyBuddha breast pump is not heat resistant, keep away from heat sources.
- Do not reach for pump if it has fallen into water. Unplug immediately.
- Never operate pump if it has a damaged cord or plug. If damage is found, discontinue use and contact BabyBuddha Products at support@babybuddhaproducts.com
- Only use AC adapter supplied with the pump.
- Never use a damaged device and replace damaged or worn parts as indicated.
- Do not use device while drowsy or sleeping.
- Do not use device while driving.
- Replace tubing immediately if mold is visible. Visit www.babybuddhaproducts.com to purchase replacement parts.
- Wash all parts that come into contact with breast or breast milk.

CAUTION: Can lead to minor injury



- Always disconnect unit from wall socket outlet.
- Do not expose unit to direct sunlight.
- If you feel pain while using unit, turn pump off and remove the flange immediately.
- Contact your healthcare professional if you continue to experience these pains.
- Wash hands thoroughly with soap and water before touching breast pump, components, and breasts.
- Separate and wash all components that come into contact with breast milk after each use.
- Discomfort may exist during first use, but using a breast pump should not cause pain.
- Do not thaw frozen breast milk in the microwave or in boiling water.

Do's & Don'ts

Insert the DC connector into the DC hole on the machine (Adapter input: 100-240V, 50/60 Hz, Output: 5V / 1 Amp), then insert the USB-C connector into the adapter. Insert adapter plug into power jack.

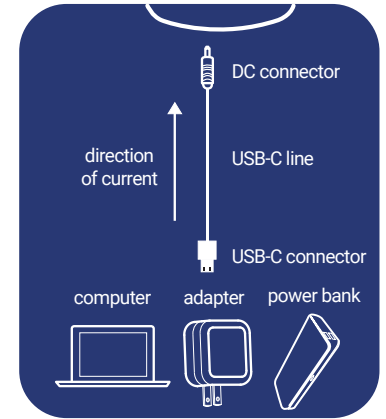

**MAINTAIN AN UPRIGHT POSITION WHILE PUMPING
IN ORDER TO PREVENT BACKFLOW. DO NOT LIE DOWN.**

Please dry water on the silicone diaphragm after cleaning and sterilizing. **Do not sterilize the PVC tube** (this is an air tube and does not come into contact with any milk).



Troubleshooting

- Read all instructions before use.
- Please use correct voltage (100v-240v).
- Only use the adapter that comes with the BabyBuddha Pump.
- If power supply cord is damaged, please contact BabyBuddha Products for a replacement.
- Do not immerse machine in water or clean with anything wet.
- Keep all components out of reach from children.
- Always unplug machine when not in use.
- This machine should only be used by a person with full knowledge of the pump.
- Please store in a cool and dry place. Excessive heat or moisture can damage the pump and accessories.
- We recommend replacing the Silicone Diaphragms every 8 weeks and the Duckbill Valves every 4-5 weeks. Replacement times may vary depending on usage and sterilization methods.

Transport & Storage Conditions

Temperature: -20° to 40°

Humidity: 10% - 70%

Atmospheric pressure: 850Hpa - 1060Hpa

Accidental milk in tubing or motor?

- Remove all tubing from machine. Wipe off any milk on the motor with a paper towel. Allow the pump to run for 20-30 seconds to remove any milk that remains inside the pump.
- Take special care to clean the vacuum ports.

If there is no suction, please follow these steps.

- Check to see that all tubing is attached securely.
- Check that tubing is clean and clear of any milk.
- Check to make sure that the massage cushion forms a complete seal around breast.
- Check to see that the machine has enough battery (recharge if battery is low) Please turn off the machine after use.

Two-Year Limited Warranty

Our lifetime warranty covers all manufacturer defects for the life of the pump (600 - 700 hours) or 2 calendar years from the date of delivery. Since our pumps are intended for a single use, our warranty is only valid for the original owner of our products. Please read the instructions thoroughly and assemble the pump correctly before use. User error or improper setup may result in pump failure and this is not covered by our warranty. Altering this pump by 'hacking' to use third party components which results in damage to the pump is considered user error and is not covered by our warranty.

If you are buying this pump as a gift, you have until 30 days after the pump is shipped to transfer the warranty. Please email SUPPORT@BABYBUDDHAPRODUCTS.COM to complete the warranty transfer. If you are experiencing a technical issue, please email a video of your issue and an explanation to SUPPORT@BABYBUDDHAPRODUCTS.COM.

A BREAST PUMP IS A PERSONAL USE ITEM AND ONCE OPENED AND USED, IT CANNOT BE RETURNED... BUT NOT TO WORRY ONE OF OUR LACTATION CONSULTANTS WILL ALWAYS BE HERE TO HELP YOU.

Feedback, questions, concerns?

Our team at BabyBuddha Products is committed to ensuring we support you on this journey with our products. We would like to hear if you have any feedback, questions, or concerns. Our customer contact email is:

SUPPORT@BABYBUDDHAPRODUCTS.COM